

Rectangle Small Hollow

Overview

CLOUDFORM COLLECTION



Specifications

LIGHTING	Integrated LED light source offering high lumen output and efficacy. Color consistency of 3 SDCM. See additional information summarizing lumen distribution, wattage, and efficacy on following pages. Tunable white option available.	DRIVERS	120-277V constant current, dimming driver standard. Can be wired dimming or non-dimming. 0-10v dimming input with a range of 1%-100%. Dim-to-Off standard. Driver can be accessed from the fixture. Power factor of > .95. Total Harmonic Distortion (THD) of < 20%.
LUMEN MAINTENANCE	Reported TM-21 Lifetimes L90(17k) = 52,600 hours L80(17k) > 102,000 hours L70(17k) > 102,000 hours	CERTIFICATION	Luminaire is CSA listed conforming to UL Standard 1598 in the U.S. and CAN/CSA C22.2 No. 250.0 in Canada. In accordance with NEC Code 410.73 (G), this luminaire contains an internal driver disconnect. Damp Location Rated. All electronic components are RoHS compliant, and the mechanical components of the luminaire have been verified to meet RoHS Directive 2002/95/EC.
CONSTRUCTION	1/16" 3form Varia. White Opal top and bottom diffuser. Contact your local sales rep for material samples.	CLEANING & CARE	Designed to withstand the demands of rigorous cleaning requirements. Effective cleaning and disinfection of environmental surfaces reduces microbe transmission. Superior chemical resistance and durability promotes safety in any design application. Use common disinfectants and cleaners to reduce microbe transmission.
ELECTRICAL	Emergency battery output: 6 watts for 90 minutes. Maximum Mounting height: 10.5ft. Compatible with Signify Bodine sinusoidal output emergency lighting inverters. Signify Bodine inverters allow designated lighting fixtures to serve as code compliant emergency lighting sources during failure of normal AC power. For additional information see link: http://www.bodine.com/products/inverter.html	WARRANTY	5 year warranty on all standard components.
MOUNTING	Adjustable stainless steel aircraft cable, contact studio for lengths over 20'. Available with multiple drop height J-hooks for group frame. Available with Grid hook for T-Grid Frame.		



Rectangle Small Hollow

Fixture Options

CLOUDFORM COLLECTION

DIMENSIONS

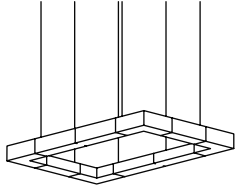

46"L x 70"W x 4"D

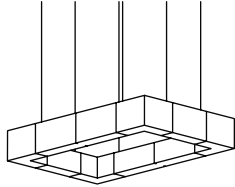

46"L x 70"W x 8"D

VARIA COLORS OPTIONS



CAULDRON
N41



ALMOND
N20



GYPSUM
N06



JARDIN
G59



CITYSCAPE
N45

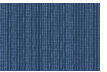

MOONSTONE
N31

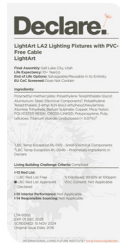

POME-
GRANATE
R37



REDWOOD
N31



GINGER
R14



SQUASH
Y14



VAPOR
W05



EARL GREY
TEAK



TOFFEE
CHESTNUT



VANILLA
ASH



HONEY OAT

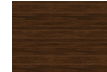

DARK
MOCHA
WALNUT

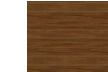

BROWN
SUGAR
WALNUT



BOURBON
CHERRY



Rectangle Small Hollow

CLOUDFORM COLLECTION

CEILING CONNECTIONS

CABLES TO CEILING

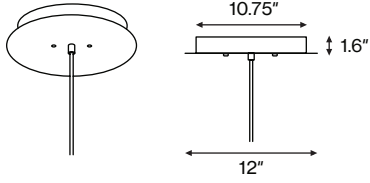

4" OCTAGONAL JUNCTION BOX (BY OTHERS)

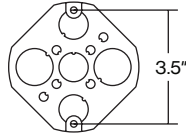

Required for powered units;
optional for unlit units

CANOPY / DRESS PLATE FINISH OPTIONS



DECK MOUNT

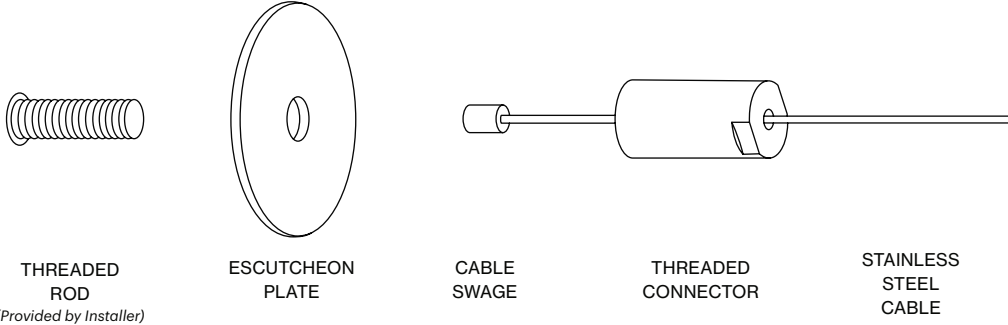

GRID MOUNT

Contact LightArt for Grid Mount hook options

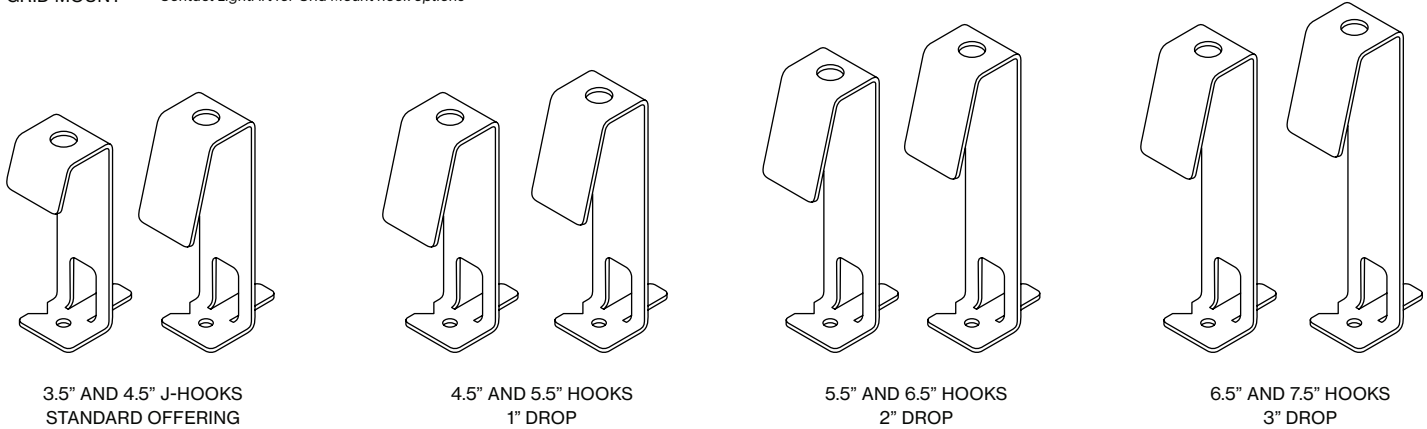

Rectangle Small Hollow

Lighting Details

CLOUDFORM COLLECTION

LIGHT DISTRIBUTION OPTIONS

Consult factory or lightart.com for IES files, tested in accordance with IESNA LM79

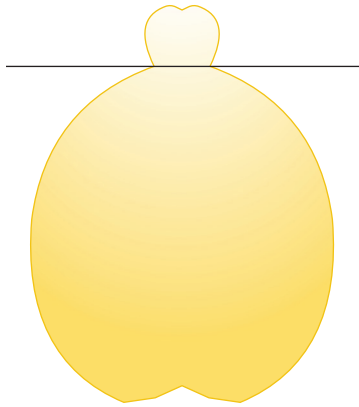

SIDE VIEW

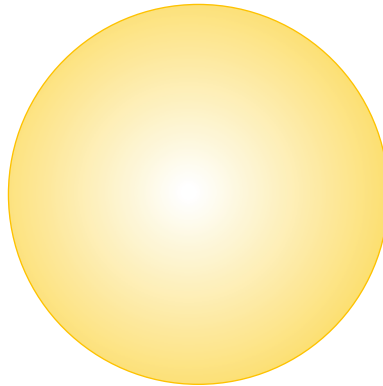

TOP VIEW

PERFORMANCE – RECTANGLE SMALL HOLLOW

Based on 3500K / 90CRI / Standard Distribution

NOMINAL LUMEN OUTPUT (LM/FT)	INPUT POWER (W/FT)	EFFICACY (LM/W)
4324	43	100
6050	61	98
7788	80	97
9516	100	95
11244	120	94
12970	141	92
14708	163	90
16436	185	89
18164	209	87
19888	233	85

LIGHT DISTRIBUTION

Based on measurement data

COLOR TEMPERATURE / CRI	MULTIPLIER
2700K / 80	0.98
2700K / 90	0.93
3000K / 80	1.02
3000K / 90	0.97
3500K / 80	1.00
3500K / 90	1.00
4000K / 80	1.08
4000K / 90	1.03

OUTPUT MULTIPLIERS INSTRUCTIONS

Adjusted Value = $L_1 \times C_m$ where:

L_1 = (Lumen output at 3500K / 90 CRI) ×

C_m = (Color Temp. / CRI Multiplier) ×

Example:

850LM / 3000K / 80CRI

$(850) \times (1.02) = 789\text{LM}$

Rectangle Small Hollow

Part Number
Specification

CLOUDFORM COLLECTION

SPECIFICATION CODE

Example: 2 QTY CLF-LIGHT-HSREC-4H-GIN-DM-STD-830CK-550LM-P01-WPC-WH

QTY. CLF-LIGHT-HSREC - - - - - - - - -

1
2
3
4
5
6
7
8
9

Complete form to order Cloudform Rectangle Small Hollow fixture(s). For each number, make one selection and enter in the corresponding box above.
*Indicates modified choices; additional lead times, cost, and limited lumen outputs may apply.

1 HEIGHT

- 4H 4" HEIGHT
- 8H 8" HEIGHT

2 MATERIAL

VARIA COLOR OPTIONS

- CAU
- MOO
- JAR
- CIT
- GYP
- CHALDRON
- MOONSTONE
- JARDIN
- CITYSCAPE
- GYPSUM

- POM
- RED
- GIN
- SQU
- ALM
- VAP
- POMEGRANATE
- REDWOOD
- GINGER
- SQUASH
- ALMOND
- VAPOR

WOOD PRINT OPTIONS

- ESW
- TCH
- VAN
- OAT
- DMW
- EGT
- BRC
- BROWN SUGAR WALNUT
- TOFFEE CHESTNUT
- VANILLA ASH
- HONEY OAT
- DARK MOCHA WALNUT
- EARL GREY TEAK
- BOURBON CHERRY

3 MOUNTING

- DM DECK MOUNT

4 SUSPENSION

- STD 12" - 96"
- EXT 12" - 240"

5 LED CRI / CCT

- 827CK 80 CRI / 2700K
- 830CK 80 CRI / 3000K
- 835CK 80 CRI / 3500K
- 840CK 80 CRI / 4000K
- 927CK 90 CRI / 2700K
- 930CK 90 CRI / 3000K
- 935CK 90 CRI / 3500K
- 940CK 90 CRI / 4000K
- TW TUNABLE WHITE
Driver selection limited to P01 and DALI

6 OUTPUT

- 250LM 250 LM/FT
 - 350LM 350 LM/FT
 - 450LM 450 LM/FT
 - 550LM 550 LM/FT
 - 650LM 650 LM/FT
 - 750LM 750 LM/FT *Max Tunable White and EM Battery Option*
 - 850LM 850 LM/FT
 - 950LM 950 LM/FT
 - 1050LM 1050 LM/FT
 - 1150LM 1150 LM/FT
 - CU* CUSTOM OUTPUT
- _____ lm

CONTINUE TO NEXT PAGE TO COMPLETE SPECIFICATION



Rectangle Small Hollow

Part Number
Specification

CLOUDFORM COLLECTION

CONTINUE SPECIFICATION

7 DIMMING AND CONTROLS

- P01 0–10V 1% DIMMING
- LEC* HI-LUME 1% ECOSYSTEM LED DRIVER SOFT ON, FADE TO BLACK (LDE1 SERIES)
- EBM 0-10V 1% DIMMING INTEGRATED EM BATTERY OPTION
*Max Lumen output limited—consult LightArt.
Not available with Tunable White.*
- DALI DALI CONTROL

8 CANOPY OPTIONS

- WPC WHITE
- BPC BLACK

9 POWER CORD

- WH WHITE
- BK BLACK

*Indicates modified choices; additional lead times, cost, and limited lumen outputs may apply.

