

## AVerMedia D331

Applies to NVIDIA Jetson T5000™/Jetson T4000™

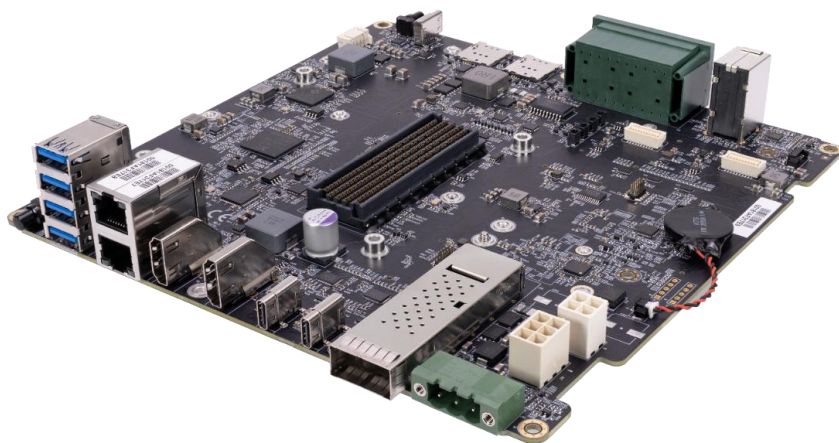

AVerMedia Technologies, Inc.

No. 135, Jian 1st Rd., Zhonghe Dist., New Taipei City 23585, Taiwan

Tel: 886-2-2226-3630

Fax: 886-2-3234-4842

Sales and Marketing: [Contact](#)

Technical Support: [Professional User](#)

---

# Table of Contents

Preface	4
Disclaimer	4
Technical Support	4
Contact Enquiry	4
Download User Manual	4
Revision History	5
<a href="https://www.avermedia.com/professional/contact">https://www.avermedia.com/professional/contact</a>	6
Product Warranty	7
Copyright Notice	7
Trademark Acknowledgement	8
ESD Warning	8
Safety Precaution:	9
<b>1.0 Introduction</b>	<b>10</b>
1.1 Product Specifications	11
1.2 Product Overview	12
1.3 Connector Summary	14
1.4 Carrier Board Interface	15
<b>2.0 Feature Description</b>	<b>17</b>
2.1 Jetson module Connector	17
2.2 Fan Power connector	17
2.3 RTC Battery Connector	18
2.4 HDMI OUTPUT	18
2.5 USB 3.2 Gen2 Type C Connector (supports Nvidia Jetson flashing)	18
2.6 USB Type C Power Supply Connector	19

<b>2.7 USB 2.0 Type C Connector (Debug UART)</b>	<b>19</b>
<b>2.8 M.2 E key 2230</b>	<b>19</b>
<b>2.9 M.2 M key 2280</b>	<b>20</b>
<b>2.10 M.2 B key 3042/3052</b>	<b>20</b>
<b>2.11 Mini card socket</b>	<b>20</b>
<b>2.12 Gigabit Ethernet Connector</b>	<b>21</b>
<b>2.15 Micro SIM Card Slot</b>	<b>22</b>
<b>2.16 2x10 Euro Terminal Block 1x CAN-FD</b>	<b>23</b>
<b>2.17 2x10pin expansion header-1</b>	<b>24</b>
<b>2.18 2x10pin expansion header-2</b>	<b>25</b>
<b>2.19 Terminal block 3Pin</b>	<b>26</b>
<b>2.20 Input Power – 4.2mm Pitch ATX Power 4P</b>	<b>26</b>
<b>2.21 Input Power – 4.2mm Pitch ATX Power 6P</b>	<b>27</b>
<b>2.22 Board to board connector (to Camera board)</b>	<b>27</b>
<b>2.23 40pin coaxial connector</b>	<b>28</b>
<b>2.24 OOB Board Connector #1 (for optional OOB board)</b>	<b>28</b>
<b>2.25 OOB Board Connector #2 (for optional OOB board)</b>	<b>29</b>
<b>2.26 OOB board connector (Power)</b>	<b>30</b>
<b>2.27 Switch Button</b>	<b>31</b>
<b>2.28 Switch Button</b>	<b>33</b>
<b>2.29 Power &amp; Recovery Button</b>	<b>33</b>
<b>2.30 3.5 mm audio jack</b>	<b>33</b>
<b>2.31 10-pin JTAG Header</b>	<b>34</b>
<b>3.0 Installation</b>	<b>35</b>
<b>3.1 BSP Setup Instructions</b>	<b>35</b>
<b>4.0 Software</b>	<b>36</b>

**5.0 Force Recovery Mode..... 38**

**6.0 Accessory Drawings ..... 39**

**6.1 Power Cord \_\_\_\_\_ 39**

**7.0 Daughter board introduction ..... 42**

**7.1 D331 + ERMi Module \_\_\_\_\_ 42**

**7.2 D331 + USB Daughter Board \_\_\_\_\_ 43**

**7.3 D331 + GMSL Daughter Board \_\_\_\_\_ 44**

**7.4 D331 + POE Daughter Board(TBD) \_\_\_\_\_ 44**

## **Preface**

### **Disclaimer**

The information contained in this user manual, including but not limited to any product specification, is subject to change without notice. AVerMedia assumes no liability for any damage incurred directly or indirectly from any technical or typographical errors or omissions contained herein or for discrepancies between the product and the user manual.

### **Technical Support**

If you experience the difficulty after reading this manual and/or using the product, please contact the reseller from which you purchased the product. In most cases, the reseller can help you with the product installation and the difficulty you encountered.

In case the reseller is not able to resolve your problem, our highly capable global technical support team can certainly assist you. Our technical support section is available 24 hours a day and 7 days a week through our website, with the [click here](#). For more contact information, you may find it in the section of AVerMedia Global Offices.

### **Contact Enquiry**

For more information of our products, pricing, and order placement, please fill in our inquiry form [here](#), we will contact you within 24 hours.

### **Download User Manual**

Please click the link [here](#) to download the file of this user manual from AVerMedia website.

## Revision History

Revision	Date	Updates
V0.1	Jan 29, 2026	1st Released
V0.2	Feb 2, 2026	Remove Fan Module Power Adapter Power Cord wrong information
V1.0	Feb 13,2026	Update 2.0 Feature Description 9.0 Daughter board introduction
V1.1	Feb 23,2026	Error Fix Add OOB demo connection
V1.2	Mar 3,2026	Error Fix Add 2.17 2.18 pinout/pin definition
V1.3	Mar 5,2026	Error Fix
V1.4	Mar 25,2026	Product spec change 2.6 USB Type C Power Supply Connector
V1.5	Mar 26,2026	Error Fix
V1.6	Apr 21,2026	Error Fix
V1.7	May 12,2026	Error Fix P.11~P.12
V1.8	May 27, 2026	Updated SSD Storage Spec Gen5 → Gen4

## AVerMedia Global Offices

<https://www.avermedia.com/professional/contact>

### Headquarters

#### Taiwan Office

No. 135, Jian 1st Rd., Zhonghe Dist., New Taipei City 23585, Taiwan

Tel:  +886-2-2226-3630

Fax: +886-2-3234-4842

Sales & Marketing: [Contact](#)

Technical Support: [Home users](#) / [Professional users](#)

---

### The Americas

#### USA Office

4038 Clipper Court Fremont, CA 94538

Tel:  (510) 403-0006

Fax: (510) 403-0022

Sales & Marketing: [Contact](#)

Technical Support: [Home users](#) / [Professional users](#)

#### Brazil Office

Sales & Marketing: [Contact](#)

Technical Support: [Home users](#) / [Professional users](#)

#### Latin America Office

Sales & Marketing: [Contact](#)

Technical Support: [Home users](#) / [Professional users](#)

---

### Europe

#### Head Office EU

AVT Solutions GmbH

Hanauer Landstrasse 291 B 60314 Frankfurt Hessen

Germany

 technicalsupport\_120

Sales & Marketing: [Contact](#)

Technical Support: [Home users](#) / [Professional users](#)

#### Russia Office

Sales & Marketing: [Contact](#)

Technical Support: [Home users](#) / [Professional users](#)

Professional Solutions Support Tel:

 +7 (925) 834-0310

#### Spain Office

AVerMedia Europe Group

Ronda de Poniente no. 4 segundo H 28760 Tres cantos, Madrid

Spain:

 technicalsupport\_120

Sales & Marketing: [Contact](#)

Technical Support: [Home users](#) / [Professional users](#)

---

### Asia-Pacific

#### China Office

Room 1510, No.488, Hitech Plaza, South Wuning Rd., Jingan District, Shanghai, China

Tel:  +86-021-5298 7985

Fax: +86-021-5298 7981

Sales & Marketing: [Contact](#)

Technical Support: [Home users](#) / [Professional users](#)

#### Japan Office

6F, Kojimachi Syuei Bldg, 4-3-13 Kudan-minami, Chiyoda-ku, Tokyo, 102-0074, Japan

Sales & Marketing: [Contact](#)

Technical Support: [Home users](#) / [Professional users](#)

## Product Warranty

Please refer to [Support | Warranty And Rma Services | AVerMedia](#)

## Copyright Notice

The information contained in this document is subject to change without notice. AVerMedia shall not be liable for errors contained herein or for incidental consequential damages in connection with the furnishing, performance, or use of this material. This document contains proprietary information that is protected by copyright. All rights are reserved. No part of this document may be photocopied, reproduced, or translated to another language without the prior written consent by AVerMedia.

## **Trademark Acknowledgement**

AVerMedia acknowledges all the trademarks, registered trademarks, and/or copyrights referred to in this document as the property of their respective owners. Not listing all possible trademarks or copyright acknowledgments does not constitute the lack of acknowledgment to the rightful owners of the trademarks and copyrights mentioned in this document.

## **ESD Warning**

Electronic components and circuits are sensitive to Electrostatic Discharge (ESD). When handling any circuit board assemblies including AVerMedia products, it is highly recommended that ESD safety precautions can be observed. ESD safe best practices can include but are not limited to the following ones.

1. Leave the circuit board in the antistatic package until it is ready to be installed.
2. Use a grounded wrist strap when handling the circuit board. At a minimum, you need to touch a grounded metal object to dissipate any static charge, which may be present on you.
3. Avoid handling the circuit board in the carpeted areas.
4. Handle the board by the edges and avoid contact with the components.
5. Only handle the circuit boards in ESD safe areas, which may include ESD floor and/or table mats, wrist strap stations, and ESD safe lab coats.

**Safety Precaution:**

1. All cautions and warnings on the device should be noted.
2. For safety consideration, do NOT open the device if not a qualified service staff.
3. Place the device on a solid surface during installation to prevent falls.
4. Keep the device away from humidity.
5. Do NOT leave this device in an un-controlled environment with temperatures beyond the device's permitted storage temperature to avoid damage.
6. All adaptors and cables supplied by AVerMedia are verified. Do NOT use any others not supplied by AVerMedia to avoid any malfunction or fires.
7. Make sure the power source matches the power rating of the device.
8. Place the power cord where people cannot step on it. Do not put anything on the power cord.
9. Always completely disconnect the power while the device is not used or idle for a long time.
10. Disconnect the device from any AC supply before cleaning. While cleaning, use damp cloth instead of liquid or spray detergents.
11. Make sure the device is installed near a power outlet and easy for accessibility.
12. Do not cover the openings on the device to ensure optimal heat dissipation.
13. Watch out the heatsink or heat spreader of the device when the system is running.
14. Never pour any liquid into the openings. This could cause fire or electrical shock.
15. The static electricity should be noted while installing any internal components. Consider using a grounding wrist strap and put all electronic parts in static-shielded containers.

If the following situations occur, please contact our service personnel:

- (1) The device is dropped or damaged
  - (2) Damaged power cord or plug
  - (3) Exposure to moisture
  - (4) Liquid intrusion into the device
  - (5) Any obvious signs of damage displayed on the device
  - (6) The device is not working as expected or in a manner as described in this manual
16. The static electricity should be noted while installing any internal components. Consider to

## 1.0 Introduction

AVerMedia D331 is a high-performance carrier board designed to support the NVIDIA® Jetson Thor™ module industry platform. Built with a comprehensive set of I/O interfaces including dual GbE, QSFP for high-speed networking, multiple M.2 expansion slots, rich peripheral connectivity, and robust industrial-grade design, the D331 enables rapid development and deployment of AI-driven embedded IoT solutions.

Equipped with a powerful NVIDIA Jetson T5000™/T4000™ system-on-module and a wide range of connectivity options such as HDMI, USB 3.2, CAN bus, PWM, and camera interfaces, the D331 carrier board delivers a flexible and scalable platform for demanding applications in autonomous mobile robotics (AMRs), smart security, smart inspection, and other edge computing use cases.

## 1.1 Product Specifications

<b>NVIDIA Jetson SoM</b>	NVIDIA Jetson T5000™/Jetson T4000™
<b>Networking</b>	<ul style="list-style-type: none"> <li>• 2x GbE RJ-45 (1 × port supports OOB NCSI for optional OOB module)</li> <li>• 1x QSFP (4× 10 GbE for JetPack 7.1 / 4 x 25 GbE for JetPack 7.2)</li> <li>• 1x M.2. key E 2230 for Wi-Fi 6</li> <li>• 1x M.2 Key B 3042/3052 for 4G/5G</li> </ul>
<b>SIM Slot</b>	• 2x SIM slots for 4G/5G module; dual SIM capability depends on the installed cellular module
<b>Display Output</b>	2 x HDMI output (3840 x 2160 at 60Hz)
<b>Temperature</b>	<p>Operating temperature: -40 to 85°C (carrier board, W/O audio)          Operating temperature: -25 to 85°C (carrier board, W/ audio)          Storage temperature -40°C ~ 85°C          Relative humidity 40 °C @ 95%, Non-Condensing</p>
<b>GMSL camera board</b>	1x 120pin for GMSL camera board
<b>USB</b>	<ul style="list-style-type: none"> <li>• 1x USB 3.2 Type-C for BSP install</li> <li>• 1x USB 3.2 Type-C (usage limitations apply; refer to User Manual for details)</li> <li>• 4x USB 3.2 Type-A (5Gbps x2 ; 10Gbps x2)</li> <li>• Optional 8x USB3.2 Type-A (via daughter board)</li> </ul>
<b>Storage</b>	<ul style="list-style-type: none"> <li>• 2x NVMe M.2 Key M 2280             <ul style="list-style-type: none"> <li>-1x NVMe M.2 Key M 2280 x2 PCIe Gen4 (8xPoE, 8xUSB board, either one)</li> <li>-1x NVMe M.2 Key M 2280 x4 PCIe Gen4</li> </ul> </li> </ul>
<b>Expansion Header</b>	<ul style="list-style-type: none"> <li>• 2x10 Euro Terminal Block 1x CAN-FD (Isolated 3KV), 3x CAN-FD with Transceiver, +5V output 1A, +3.3V output 1A,UART, I2C</li> <li>• 20pin expansion header-1: 1x5V(Maximum 1A), 1x3.3V(Maximum 1A) power Output, UARTH1, I2C, GPO(4), GPI(5), PWM(2)</li> <li>• 20pin expansion header-2: 1x5V(Maximum 1A), 1x3.3V(Maximum 1A) power Output, UARTH2, I2C, GPO(4), GPI(5), PWM(2)</li> <li>• 2x 5-pin JTAG connector</li> <li>• 1x 40pin coaxial connector for PCIe expansion (daughter board 8xPSE/8xUSB )</li> </ul>
<b>Power requirement</b>	<ul style="list-style-type: none"> <li>• Terminal block 3Pin &amp; Mini-fit 6pin (Internal)</li> <li>• USB Type C Power Supply</li> <li>• 9~36V (Max rating) DC Input</li> <li>• ACC IN / IGN Control (ACC optional, via switch)</li> </ul>
<b>Thermal Solution</b>	<ul style="list-style-type: none"> <li>• 1x SOM FAN</li> <li>• 2x Chassis Fan (12V fan wafer)</li> </ul>
<b>Buttons</b>	Power and Recovery
<b>RTC Battery</b>	Support RTC Battery and Battery Life Monitoring by MCU



## Front View and Back View of Carrier board

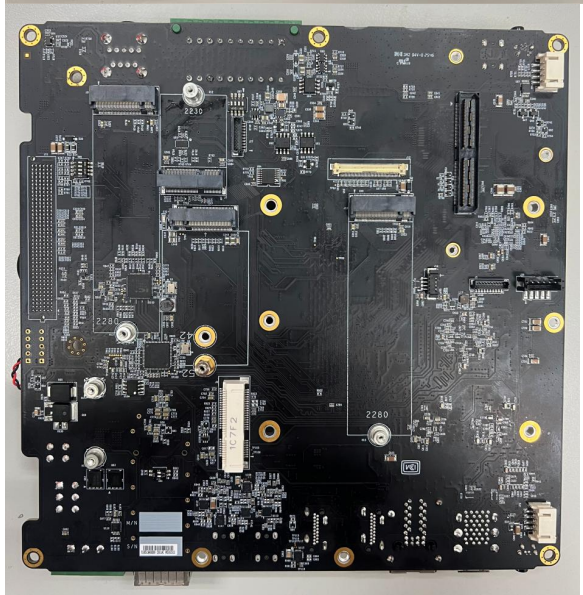
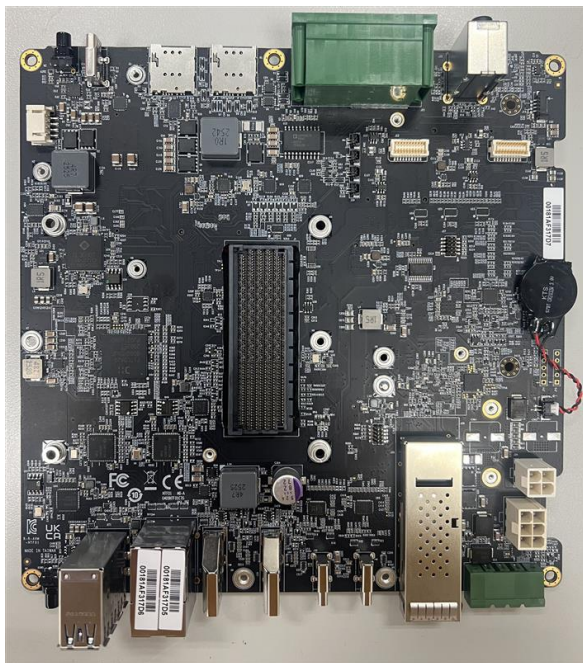

## 1.3 Connector Summary

J1	699-pin high-speed/high-density connector
J16	Fan Wafer
J3	External RTC Battery wafer
J18	HDMI output Type-A Vertical Side Connector (Female)
J19	HDMI output Type-A Vertical Side Connector (Female)
J31	USB 3.2 Gen2 Type C Connector (supports Nvidia Jetson flashing)
J30	USB Type C Power Supply Connector
J17	USB 2.0 Type C Connector (Debug UART)
J4	Gigabit Ethernet Connector w/LEDs
J10	Micro SIM card socket (Push-Push)
J21	2x10 Euro Terminal Block 1x CAN-FD
J22	20pin expansion header-1
J23	20pin expansion header-2
J29	QSFP
J32	Input Power – 4.2mm Pitch ATX Power 6P
J33	Input Power – Terminal block 3Pin
J34	Input Power – 4.2mm Pitch ATX Power 4P
J35	3.5mm audio Jack
J2	5 pin JTAG Header
J24	OOB board connector (Power)
J25	OOB board connector (Reset)
J26	OOB board connector (Recover)
BSW1	Recovery Button w/LEDs
BSW3	Power Button w/LEDs
J36	M.2 M-Key Socket
J8	USB 3.2 Gen2 Type A Connector
J7	M.2 E-Key Socket
J9	M.2 B-Key Socket
J6	Mini card socket
J27	OOB connector
J5	OOB NCSI connector
J14	4-pin USB wafer
J38	5-pin 12V DC output wafer

J39	M.2 M-Key Socket
J20	120-pin high speed board to board connector (to Camera board)
J12	40-pin coaxial connector
JP1	Fan Wafer
JP2	Fan Wafer
SW7	Switch Button
SW8	Switch Button
SW9	Switch Button

## 1.4 Carrier Board Interface

### Top View Interface

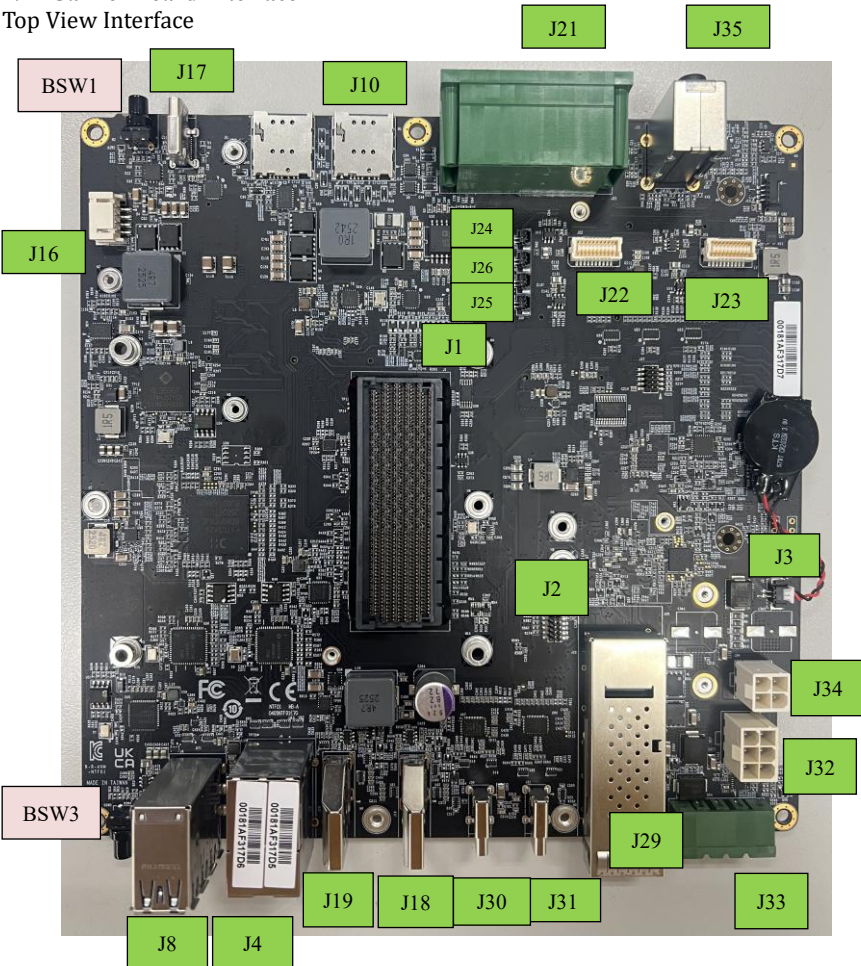

**Bottom view Interface**

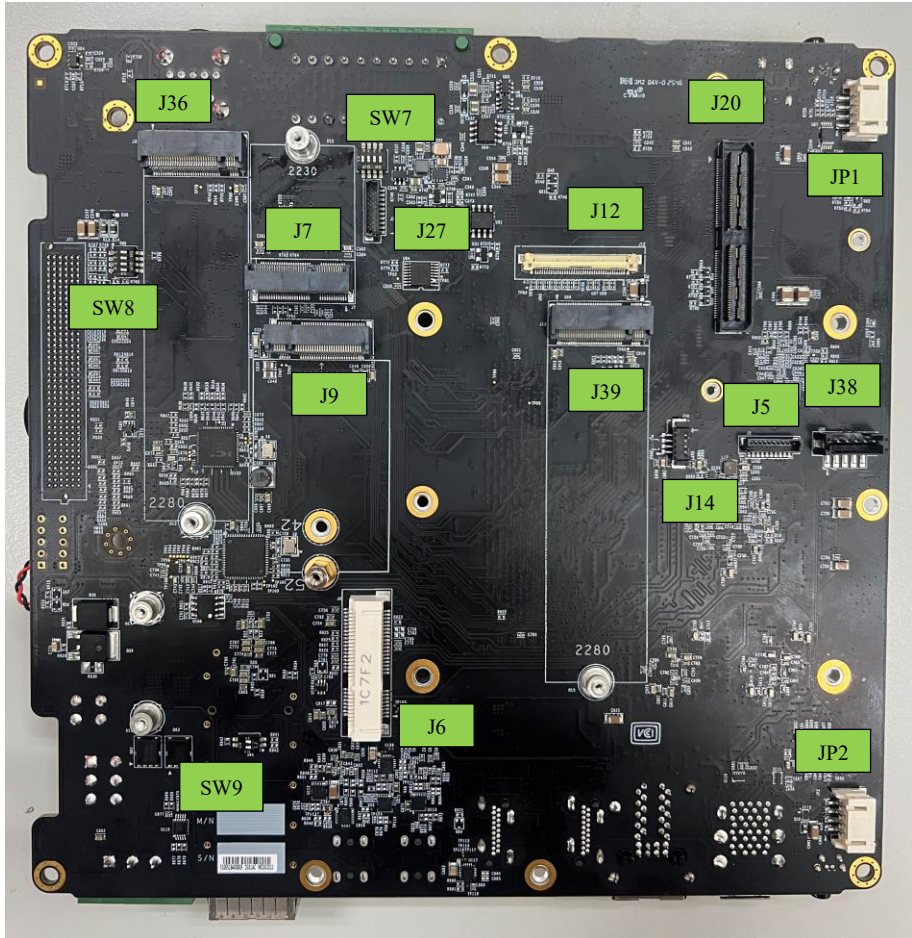

## 2.0 Feature Description

### 2.1 Jetson module Connector

Function	Provide connection with NVIDIA® Jetson™ AGX Thor™ module	
Location	J1	
Type Description	MOLEX 699pin socket	
Manufacturer and Part Number	MOLEX,203456-0003	
Mating Connector	MOLEX,203456-0003	
Pinout	Please refer to NVIDIA Jetson™ AGX Thor™ System-on-Module datasheet for pinout details.	
Remarks	<a href="https://developer.nvidia.com/embedded/downloads">https://developer.nvidia.com/embedded/downloads</a>	



### 2.2 Fan Power connector

Function	Fan Power Connector		
Location	J16 / JP1 / JP2		
Type Description	WAFER_1*4PIN_2 mm_90°_SMD		
Manufacturer and Part Number	JOINT TECH 燦達 A2001WR-S-04PNLNT1T00R		
Mating Connector	JOINT TECH 燦達 A2001 Series Housing		
Pinout	Pin #	Description	
	PIN 1	GND	
	PIN 2	+12V Power	
	PIN 3	FAN_TACH	
	PIN 4	FAN_PWM	
Remarks	None		

## 2.3 RTC Battery Connector

Function	RTC battery for module		
Location	J3		
Type Description	1.25mm wire-to-board header		
Manufacturer and Part Number	宏致_ACES 50271-00201-001_BLACK		
Mating Connector	Molex, 51021-8602		
Pinout	Pin #	Description	
	PIN1	GND	
	PIN2	3V Power	
Remarks	RTC Battery:, CR2032 3V		

## 2.4 HDMI OUTPUT

Function	HDMI output connector		 
Location	J19/J18		
Type Description	HDMI Type-A female connector		
Manufacturer and Part Number	捷湧 EDL TECHNOLOGY CO. HM-FVD480B		
Mating Connector	Any HDMI standard Type-A interface cable or device.		
Pinout	Please refer to HDMI standard.		
Remarks	None		

## 2.5 USB 3.2 Gen2 Type C Connector (supports Nvidia Jetson flashing)

Function	BSP Installation as recovery mode		
Location	J31		
Type Description	USB3.2 Type-C female connector		
Manufacturer and Part Number	GM9-HF_JACK_建倚_SBC-240P- 31HF-S277_-55+85°C		
Mating Connector	Any Standard Type-C interface cable or device.		
Pinout	Please refer to USB 3.2 Gen 2 standard.		
Remarks	J31 supports Nvidia Jetson flashing		

## 2.6 USB Type C Power Supply Connector

Function	USB Type -C power supply	
Location	J30	
Type Description	USB3.1 Type-C female connector	
Manufacturer and Part Number	GM9-HF JACK_建倚_SBC-240P-31HF-S277_-55+85°C	
Mating Connector	Any Standard Type-C interface cable or device.	
Pinout	Please refer to USB 3.1 type- C standard	
Remarks	NONE	

## 2.7 USB 2.0 Type C Connector (Debug UART)

Function	For dumping debug UART	
Location	J17	
Type Description	USB2 .0 Type-C female connector	
Manufacturer and Part Number	GM9-HF JACK_建倚_SBC-240P-31HF-S277_-55+85°C	
Mating Connector	Any Standard Type-C interface cable or device.	
Pinout	Please refer to USB 2.0 standard.	
Remarks	None	

## 2.8 M.2 E key 2230

Function	M.2 E-Key for wifi module	
Location	J7	
Type Description	SOCKET_M.2-KEY E_75PIN 90°_SMD	
Manufacturer and Part Number	宏致 ACES 51748-07502-005_P0.5 mm-H8.5 mm	
Mating Connector	Any M.2 E key 2230 card standard interface device.	
Pinout	Please refer to M.2 E key card standard for the pinout details.	

Remarks	None
---------	------

## 2.9 M.2 M key 2280

Function	M.2 M-Key	
Location	J36/J39	
Type Description	SOCKET_M.2-M KEY_75PIN_90°_SMD	
Manufacturer and Part Number	宏致_ACES 51757-0750C-012_P0.5 mm-H5.5 mm	
Mating Connector	Any M.2 M key 2280 card standard interface device.	
Pinout	Please refer to M.2 M key card standard for the pinout details.	
Remarks	J39 only support PCIe 2-Lane	

## 2.10 M.2 B key 3042/3052

Function	M.2 B-Key for 4G/5G module	
Location	J9	
Type Description	SOCKET_M.2-KEY_B_75PIN_90°_SMD	
Manufacturer and Part Number	鴻海_Foxconn 2E0BC21-S85BB-7H_90°_H8.5 mm	
Mating Connector	Any M.2 B key 2280 card standard interface device.	
Pinout	Please refer to M.2 B key card standard for the pinout details.	
Remarks	None	

## 2.11 Mini card socket

Function	Mini Card (PCIe) interface	
Location	J6	
Type Description	SOCKET_MINI_PCIE_52PIN	
Manufacturer and Part Number	FOXCONN, AS0B221-S68Q 7H_H=6.8MM-062AL6	
Mating Connector	Any Mini Card standard interface device.	

Pinout	Please refer to Mini Card standard for the pinout details.	
Remarks	None	

## 2.12 Gigabit Ethernet Connector

Function	1Gb single-port Ethernet connector, used to connect to the host system.	
Location	J4	
Type Description	JACK_RJ45*2_TRANSFOMER+LED_90°_DIP	
Manufacturer and Part Number	銘運_JDKA1S826-G/D1_1G-LED L(G)+R(G/Y)	
Mating Connector	Any standard 1Gb Ethernet mating connector can be applicable.	
Pinout	Comply with Ethernet standards.	
Remarks	None	

## 2.13 QSFP Connector

Function	QSFP Connector	
Location	J29	
Type Description	OTHERS_CAGE_20.99*61.17 mm _QSFP28-STYLE A	
Manufacturer and Part Number	GM9_OTHERS_湧德_PRESS FIT- 90°-W/O LED & HEATSINK	
Mating Connector	Any standard QSFP mating connector can be applicable	
Pinout	N/A	
Remarks	None	

### 2.14 USB 3.2 Gen2 Type A Connector

Function	General-purpose input/output	
Location	J8	
Type Description	USB 3.2 Gen2 Type A female connector	
Manufacturer and Part Number	GM9-HF_JACK_鴻海_UEA11123-QHD6-4H_-55+85°C	
Mating Connector	Any Standard Type-A interface cable or device.	
Pinout	Please refer to USB 3.2 standard.	
Note	None	

### 2.15 Micro SIM Card Slot

Function	Micro SIM Card	
Location	J10	
Type Description	SOCKET_MICRO SIM_8PIN_90°_SMD	
Manufacturer and Part Number	福軒_FG-0271AAAG06A_PUSH PUSH 1.42H	
Pinout	Refer to Micro SIM card standard Remark	
Note	<p>*Push Push type</p> <p>*Inserting directing as below</p>	

**2.16 2x10 Euro Terminal Block 1x CAN-FD**

Function	General-purpose input/output					
Location	J21					
Type Description	Expansion I/O Connector					
Manufacturer and Part Number	ME252-35020-1					
Mating Connector	2x10 Euro Terminal Block 1x CAN-FD					
Pinout	Address JP7	Pin Name	20-pin Index (Devkit Index)		Pin Name	Address JP7
		5V	A1	B1	3V3	
		GND	A2	B2	GND	
	/dev/ttyAMA5	UART5_TX_3V3 J58(UF3_TXD)	A3	B3	I2C_GP8_DAT_3V3 (E60)	i2c-3
	/dev/ttyAMA5	UART5_RX_3V3 H58(UF3_RXD)	A4	B4	I2C_GP8_CLK_3V3 (D61)	i2c-3
		ISO_GND	A5	B5	GND	
		CANL0_ISO	A6	B6	CANL2	
		CANH0_ISO	A7	B7	CANH2	
		GND	A8	B8	CANL3	
		CANL1	A9	B9	CANH3	
	CANH1	A10	B10	GND		
Note	None					

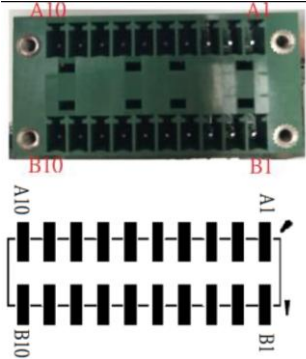

**2.17 2x10pin expansion header-1**

Function	General-purpose input/output					
Location	J22					
Type Description	WAFER_2*10PIN_1 mm_180°_SMD					
Manufacturer and Part Number	GM2_WAFER_JST_BM20B-SHLDS-G-TFT(LF)(SN)					
Mating Connector	Any Standard interface cable or device.					
Pinout	Address JP7	Pin Name	20-pin Index (Devkit Index)		Pin Name	Address JP7
		3V3	1	2	5V	
		GND	3	4	GND	
	i2c-9	I2C_GP9_DAT_3V3 (CS3)	5	6	UART1_TX_3V3	GL3590 未動作
	i2c-9	I2C_GP9_CLK_3V3 (A53)	7	8	UART1_RX_3V3	GL3590 未動作
	chip 2 gpio 127	GPI027_PMM2_3V3 PF.07 J22.9, PWM	9	10	GND	
	chip 2 gpio 16	I2S1_LBCK_PMI0_3V3 GPIO3_PV.01 (devkit Usage: SPT0_3V3_DP_IN) J22.11, PWM	11	12	SP11_SOC_3V3 GPIO3_P1.07 J22.12, GPI	chip 2 gpio 71
	chip 2 gpio 112	I2S1_SCLK_3V3 GPIO3_PR.02 J22.13, GPO High	13	14	SP11_MISO_3V3 GPIO3_PR.00 J22.14 GPI	chip 2 gpio 72
	chip 2 gpio 113	I2S1_SDOOT_3V3 GPIO3_PR.03 J22.15, GPO High	15	16	SP11_MOSI_3V3 GPIO3_PK.01 J22.16, GPI	chip 2 gpio 73
	chip 2 gpio 114	I2S1_SDI0_3V3 GPIO3_PR.04 J22.17, GPO High	17	18	SP11_CS0_3V3 GPIO3_PK.02 J22.18, GPI	chip 2 gpio 74
	chip 2 gpio 115	I2S1_LBCK_3V3 GPIO3_PR.05 J22.19, GPO High	19	20	SP11_CS1_3V3 GPIO3_PK.03 J22.20, GPI	chip 2 gpio 75
	Remarks					

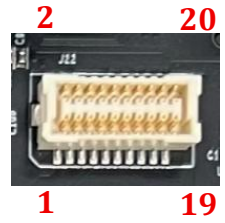

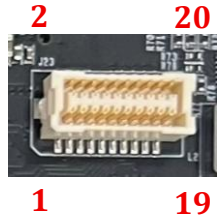

**2.18 2x10pin expansion header-2**

Function	General-purpose input/output					
Location	J23					
Type Description	WAFER_2*10PIN_1 mm_180°_SMD					
Manufacturer and Part Number	GM2_WAFER_JST_BM20B-SHLDS-G-TFT(LF)(SN)					
Mating Connector	Any Standard interface cable or device.					
Pinout	Address JP7	Pin Name	20-pin Index (Devkit Index)		Pin Name	Address JP7
		3V3	1	2	5V	
		GND	3	4	GND	
	i2c-11	I2C.GP11_DAT_3V3 (E26)	5	6	UARTH2_TX_3V3	/dev/ttyUSB0
	i2c-11	I2C.GP11_CLK_3V3 (E27)	7	8	UARTH2_RX_3V3	/dev/ttyUSB0
	chip 2 gpio 128	GP1036_PWM3_3V3 PG.00 J23.9, PWM	9	10	GND	
	chip 2 gpio 14	GP1044_PWM5_3V3 PU.07 J23.11, PWM	11	12	SPI3_SCK_3V3 GP103_P0.06 J23.12, GP1	chip 2 gpio 62
	chip 2 gpio 21	I2S2_SCLK_3V3 GP103_PV.06 J23.13, GPO High	13	14	SPI3_MISO_3V3 GP103_P0.07 J23.14, GP1	chip 2 gpio 63
	chip 2 gpio 22	I2S2_SDOOUT_3V3 GP103_PV.07 J23.15, GPO High	15	16	SPI3_MOSI_3V3 GP103_P1.00 J23.16, GP1	chip 2 gpio 64
	chip 2 gpio 23	I2S2_SDIN_3V3 GP103_PW.00 J23.17, GPO High	17	18	SPI3_CS0_3V3 GP103_P1.01 J23.18, GP1	chip 2 gpio 65
chip 2 gpio 24	I2S2_LRCK_3V3 GP103_PW.01 J23.19, GPO High	19	20	SPI3_CS1_3V3 GP103_P1.02 J23.20, GP1	chip 2 gpio 66	
Remarks						

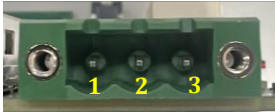

--	--

### 2.19 Terminal block 3Pin

Function	DC power input	 							
Location	J33								
Type	SOCKET_TERMINAL								
Description	BLOCK_1*3PIN_90°_DIP								
Manufacturer and Part Number	GM9_SOCKET_進聯_ME050-50803_GREEN-P5.08 mm-PIN L4.5 mm								
Mating Connector	QSFP Connector								
Pinout	<table border="1"> <thead> <tr> <th>Pin Number</th> <th>Description</th> </tr> </thead> <tbody> <tr> <td>1</td> <td>ACC</td> </tr> <tr> <td>2</td> <td>GND</td> </tr> <tr> <td>3</td> <td>DC IN</td> </tr> </tbody> </table>	Pin Number	Description	1	ACC	2	GND	3	DC IN
Pin Number	Description								
1	ACC								
2	GND								
3	DC IN								
Remarks	None								

### 2.20 Input Power – 4.2mm Pitch ATX Power 4P

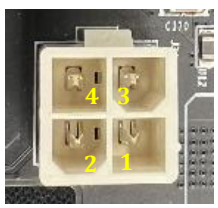
Function	ATX 4P	
Location	J34	
Type Description	WAFER_2*2PIN_4.2 mm_DIP	
Manufacturer and Part Number	福軒 Fullglory FPWD-42R2-04NAT	
Mating Connector	Follow ATX 4pin power standard	

Pinout	Pin Number	Description
	1	GND
	2	GND
	3	12-54V Power
	4	12-54V Power
Remarks	None	

### 2.21 Input Power – 4.2mm Pitch ATX Power 6P

Function	DC power input	
Location	J32	
Type Description	WAFER_2*3PIN_4.2 mm_180°_DIP-L3.5 mm	
Manufacturer and Part Number	GM1-HF_WAFER_宏致_56973-0060N-001_ATX POWER-NATURAL	
Mating Connector	Follow ATX 6pin power standard	
Pinout	Pin Number	Description
	1	12-54V Power
	2	12-54V Power
	3	ACC
	4	GND
	5	GND
6	GND	
Remarks	None	

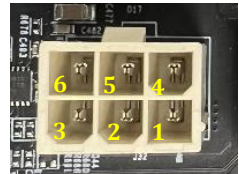

### 2.22 Board to board connector (to Camera board)

Function	Board to board connector	
Location	J20	
Type Description	WAFER_2*60PIN_0.5 mm_180°_SMD	
Manufacturer and Part Number	SAMTEC QSH-060-01-L-D-A-K-TR BTB-RECEPTACLE	

Mating Connector	SAMTEC QTH-060-03-H-A-D BTB-PLUG QTH-060-04-H-A-D BTB-PLUG	
Pinout	Comply with NVIDIA Devkit pinout.	
Remarks	None	

### 2.23 40pin coaxial connector

Function	40pin coaxial connector for daughter board	
Location	J12	
Type Description	WAFER_40PIN_0.5 mm _90°_SMD	
Manufacturer and Part Number	I-PEX 20455-040E-12	
Mating Connector	I-PEX 20453-240T-03	
Pinout	Any Standard coaxial connector interface cable or device.	
Remark	NA	

### 2.24 OOB Board Connector #1 (for optional OOB board)

Function	OOB Board Connector (for NC-SI)	
Location	J5	
Type Description	WAFER_1*10PIN_1 mm_180°_SMD	

Manufacturer and Part Number	ACES 50228-01071-001			
Mating Connector	ACES 50233-010H0H0-001			
Pinout	PIN#	Description	Module Pin#	Type/ Dir
	1	NC SI TXD0		Input, 3.3V
	2	NC SI TXD1		Input, 3.3V
	3	NC SI TX EN		Input, 3.3V
	4	GND		Ground
	5	NC SI CLK IN		Input, 3.3V
	6	GND		Ground
	7	NC SI RXD0		Output, 3.3V
	8	NC SI RXD1		Output, 3.3V
	9	NC SI CRS DV		Output, 3.3V
10	GND		Ground	
Remark	For optional OOB with NCSI board			

## 2.25 OOB Board Connector #2 (for optional OOB board)

Function	OOB Board Connector(basic function)			
Location	J27			
Type Description	WAFER_1*10PIN_1 mm_180°_SMD			
Manufacturer and Part Number	ACES 50228-01071-001			
Mating Connector	ACES 50233-010H0H0-001			
Pinout	PIN#	Description	Module Pin#	Type/ Dir
	1	GND		Ground
	2			Input, 3.3V
	3	UART3 RX (Debug OOB)		Input, 3.3V

	4	UART3 TX (Debug OOB)	Ground
	5	UART1 RX 3V3	Input, 3.3V
	6	UART1 TX 3V3	Ground
	7	+5V SOM PG	Output, 3.3V
	8	RST OOB	Output, 3.3V
	9	POWER_BTN	Output, 3.3V
	10	+5V STANDBY	Ground
Remark	For optional OOB with NCSI board		

## 2.26 OOB board connector (Power)

Function	Connector of OOB board		
Location	J24 J26 J25		
Type Description	WAFER_1*2PIN_1 mm_180°_SMD		
Manufacturer and Part Number	宏致 ACES 50228-00271-001_WTB		
Mating Connector	宏致 ACES 50233-002H0H0-001		
Pinout	J24	Description	
	PIN 1	Power	
	PIN 2	GND	
	J26	Description	
	PIN 1	Reset	
	PIN 2	GND	
	J25	Description	
	PIN 1	Recovery	

	PIN 2	GND
Remark	NA	

### 2.27 Switch Button

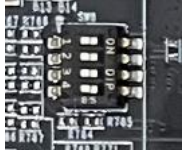
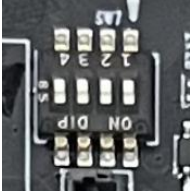
Function	Switch Button	 
Location	SW7 , SW8	
Type Description	4 SPST DIP switch	
Manufacturer and Part Number	圓達 DIPTRONICS IN OFF-SWITCHING 0.025A/24VDC	

Pinout	SW7	
	Pin #	Description
	1	OFF=>CAN0 W/O Terminal ON=> CAN0 W Terminal
	2	OFF=>CAN1 W/O Terminal ON=> CAN1 W Terminal
	3	OFF=>CAN2 W/O Terminal ON=> CAN2 W Terminal
	4	OFF=>CAN3 W/O Terminal ON=> CAN3 W Terminal
	SW8	
	Pin #	Description
	1	OFF=>Auto Power ON=>Button Power
	2	OFF=>FAN PWM ON=>FAN Always
3	OFF=>Always Powser ON Disable ON=> Always Powser ON Enable	
4	OFF=>Ignore ACC for Development ON=> ACC Enable	
Remark	NA	

## 2.28 Switch Button

Function	Switch Button		
Location	SW9		
Type Description	SW_DIP_NDSVM-02Q-T-R_SMD4		
Manufacturer and Part Number	GM1-HF_SWITCH_冠泰_IN OFF-SWITCHING 0.025A/24VDC		
Pinout	SW9		
	Pin #	Description	
	1	OFF=>PCIe x8 ON=> PCIe x	
2	OFF=>Mini Card set as GPS ON=> Mini Card set as PCIe		
Remark	None		

## 2.29 Power & Recovery Button

Function	Power & Recovery control button	
Location	BSW1, BSW3	
Type Description	Button	
Manufacturer and Part Number	冠泰 Champway 12VDC/0.05A-160G-H1.8 mm-BLACK	
Pinout	N/A	
Remark	None	

## 2.30 3.5 mm audio jack

Function	MIC in / Headphone output	
Location	J35	
Type Description	JACK_PHONE*2_D3.5-BLACK_90°_DIP	
Manufacturer and Part Number	GM1_JACK_京政_PJD-035-87HAB	
Top : MIC in	Top : MIC in	

Buttom : Headphone out	Buttom : Headphone out
Remark	None

### 2.31 10-pin JTAG Header

Function	<b>JTAG</b>																											
Location	J2																											
Type Description	HEADER_PIN_2*5PIN_1.27 mm _180°_SMD																											
Manufacturer and Part Number	冠泰_PH13-10VM1002CU8-06																											
Pinout	<table border="1"> <thead> <tr> <th>Pin</th> <th>Description</th> <th>Pin</th> <th>Description</th> </tr> </thead> <tbody> <tr> <td>1</td> <td>JTAG_TMS</td> <td>2</td> <td>+1.8V</td> </tr> <tr> <td>3</td> <td>JTAG_TCK</td> <td>4</td> <td>GND</td> </tr> <tr> <td>5</td> <td>JTAG_TDO</td> <td>6</td> <td>GND</td> </tr> <tr> <td>7</td> <td>JTAG_TDI</td> <td>8</td> <td>GND</td> </tr> <tr> <td>9</td> <td>RESET_IN</td> <td>10</td> <td>GND</td> </tr> </tbody> </table>	Pin	Description	Pin	Description	1	JTAG_TMS	2	+1.8V	3	JTAG_TCK	4	GND	5	JTAG_TDO	6	GND	7	JTAG_TDI	8	GND	9	RESET_IN	10	GND			
	Pin	Description	Pin	Description																								
	1	JTAG_TMS	2	+1.8V																								
	3	JTAG_TCK	4	GND																								
	5	JTAG_TDO	6	GND																								
	7	JTAG_TDI	8	GND																								
9	RESET_IN	10	GND																									
Remark	None																											

### Other Switches and Jumpers

Other switches and jumpers listed on the board but not mentioned in this manual are reserved for internal use by AVerMedia. They are not open to the client application.

### 3.0 Installation

- Check and ensure all external system power supplies are turned off.
  - Connect the power cord to CB/devkit/Box PC DC in jack or ATX 4pin
  - Connect the USB Type-C cable to CB/devkit/Box PC connector.
  - Press and hold on the Recover button
  - Plug in AC power
- (Since the DCINJACK is slightly tight, be careful not to shake it when inserting the CB/devkit/Box PC)

#### 3.1 BSP Setup Instructions

BSP (board support package) file: AVERMEDIA\_JETPACK-R2.\*.\*.\*\_desktop.tar.gz for D331

If you want to get the BSP download link, please contact AVerMedia FAE.

Default login username/password of the BSP is nvidia/nvidia

If you have difficulties to access the BSP download link, please visit AVerMedia website at <https://www.avermedia.com/professional/download>, or contact technical support at [https://www.avermedia.com/professional/technical\\_support](https://www.avermedia.com/professional/technical_support) or e-mail us at [esusupport@avermedia.com](mailto:esusupport@avermedia.com) for further assistance.

BSP Installation steps for NVIDIA Jetson board: (Important Note: Please backup your personal files before re-flashing BSP)

After you download the BSP file and put the file in a Linux PC, please refer to the steps below to re-flash BSP.

#### 1. Let the JETSON AGX Thor initiate recovery mode.

You have to keep pressing “Recovery” button and then power on the NVIDIA Jetson board to initiate recovery mode.

When connecting a NVIDIA Jetson board to a Linux PC via a USB Type-C to USB cable, you can check kernel messages with `dmesg` command in the Linux PC.

Once you see similar messages as below, it means that the NVIDIA Jetson board is in the recovery mode.

[24685.229129] usb 1-7: Product: APX

[24685.229132] usb 1-7: Manufacturer: NVIDIA Corp

## 2. Using the commands below in the Linux PC to start re-flashing BSP.

# sudo is required to extract BSP

\$ sudo tar zxvf AVERMEDIA\_JETPACK- R2.\*.\*.\*\_desktop.tar.gz

\$ cd JetPack\_\*.\*\*\_desktop/Linux\_for\_Tegra

\$ installation steps: refer to AVERMEDIA\_JETPACK- R2.\*.\*.\*\_ReleaseNote.txt

## 4.0 Software

This section describes BSP's features for D331

1. Support optional M.2 WI-FI/Bluetooth modules (Intel® Wireless-AX210), the manager UI of AX210 WiFi/Bluetooth is located on the upper-right corner of Ubuntu desktop. It can be also controlled by nmcli/bluetoothctl in command line.
2. Power Mode  
Power mode can be modified by the UI on the upper-right corner of Ubuntu or the following commands.

```
# get current power mode
$ sudo nvpmode -q
# setup power mode
# where <x> is power mode number, please refer to
https://docs.nvidia.com/jetson/archives/r36.4.3/DeveloperGuide/SD/PlatformPowerAndPerformance/JetsonOrinNanoSeriesJetsonOrinNxSeriesAndJetsonAgxOrinSeries.html#supported-modes-and-power-efficiency for more
information
$ sudo nvpmode -m <x>
```

### RTC Battery

The following command can get RTC battery voltage.

```
$ sudo avt tool -a | grep -oP "AIN5.*\[\K[^\]]*"
```

3. Fan Speed  
The following commands can get PWM fan information.

```
# get current speed setting of PWM Fan (0 ~ 255)
```

```
$ cat /sys/devices/platform/pwm-fan/hwmon/hwmon<x>/pwm1  
  
# get Fan RPM value  
$ cat /sys/class/hwmon/hwmon<y>/rpm  
  
* Where <x> and <y> are dynamic hwmon indexes.
```

4. CAN Bus (removed to daughter board)
5. Camera (removed to daughter board)
6. GPIO usage

(1) Locate the GPIO Pin:

Use the `gpiofind` command to determine the pin's location in the system. For example,

to locate the SODIMM Pin 99, which corresponds to PX.04, execute:

```
$ sudo gpiofind PX.04
```

```
# This command will return the GPIO chip and offset. For example, it might return  
gpiochip0 118, indicating that PX.04 is at offset 118 on gpiochip0
```

(2) Set the GPIO Pin Voltage:

Set High Voltage: To set the pin to a high voltage (logic level 1), use the following command:

```
$ sudo gpiowrite --mode=wait 0 118=1
```

Set Low Voltage: To set the pin to a low voltage (logic level 0), use this command:

```
$ sudo gpiowrite --mode=wait 0 118=0
```

For L4T (Linux for Tegra) BSP support and the other software support associated with NVIDIA® Jetson AGX Thor, please visit AVerMedia website to contact our technical support function. (<https://www.avermedia.com/tw/support/contact>)

## 5.0 Force Recovery Mode

USB Type-C port (J31) of D331 can be used to re-program NVIDIA® Jetson AGX Thor by using the other host system running NVIDIA Jetpack, as the procedure described below.

1. Before you start
  - Please make sure to use a Linux host PC with Ubuntu 22.04 or 20.04 operating system.
  - Please use a native setup (no virtual machine) installation file in the following steps.
  - You will also need a high-quality standard USB Type C connector.
  - Download installation file from AVermedia.
2. Connect carrier board to host PC
3. Connect the system to the Linux host PC. Please use a USB Type C cable (J31 on the carrier board).
4. After connecting to the host PC powering up the system. The system will detect the host PC and automatically enter the flashing state (also called force recovery mode).
5. Check that the connection is established with the `lsusb` command. You should find one entry with Nvidia Corp. as highlighted below.
6. Flashing of system
  - Use the flash cmd script in the extracted bootloader folder to transfer the software into the Jetson compute module and flash it.
  - Please connect a monitor to the system. After the flashing process has completed the should automatically boot and show the Ubuntu desktop.
  - You now have a functioning system ready for your needs.

## 6.0 Accessory Drawings

### 6.1 Power Cord

#### 64APOWBRX-IPD (TW version)

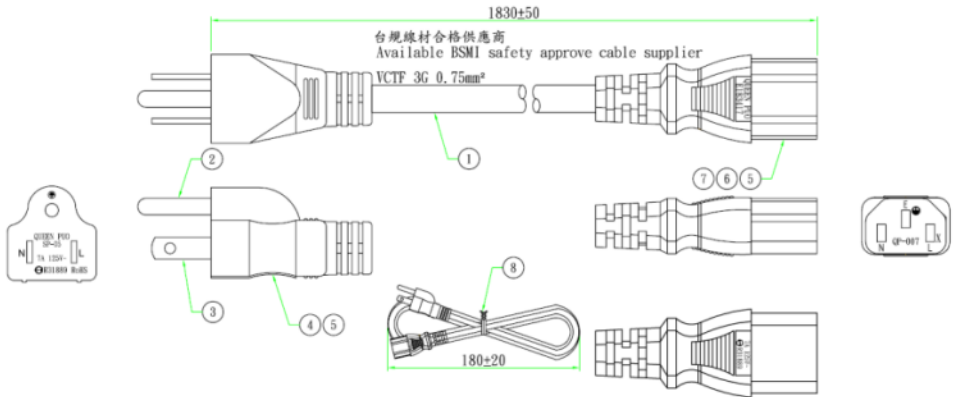

#### 064APOWBR2-IPD (US version)

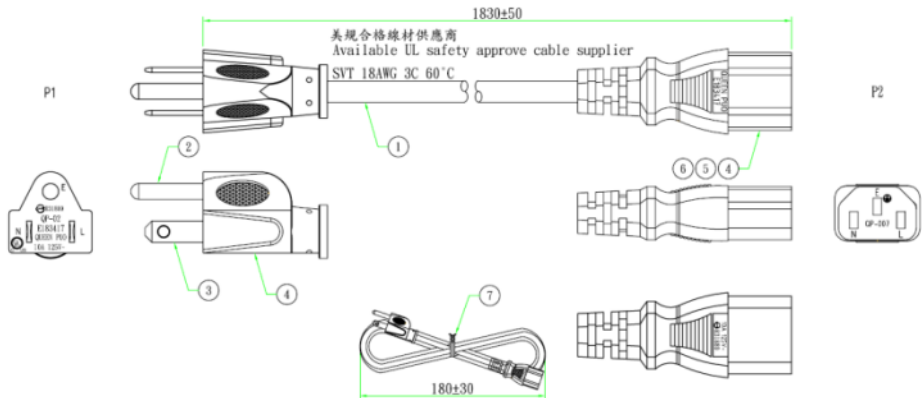

#### 064APOWBRW-IPD (UK version)

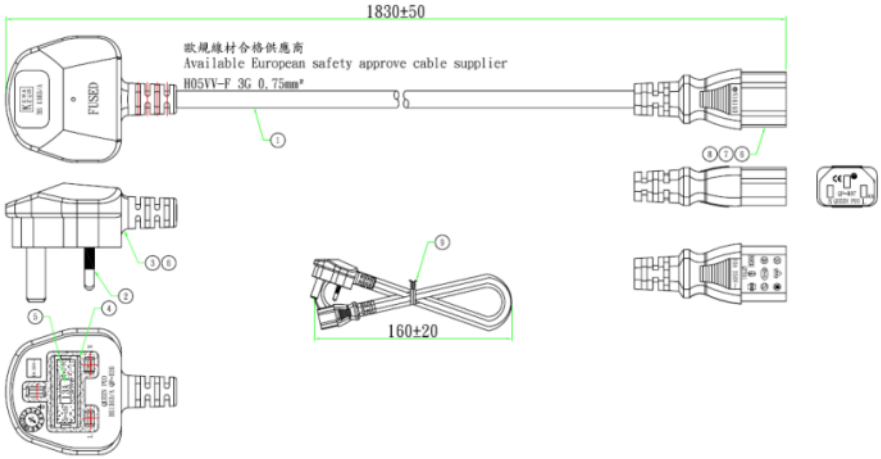

## 064APOWERBR5-IPD (EU version)

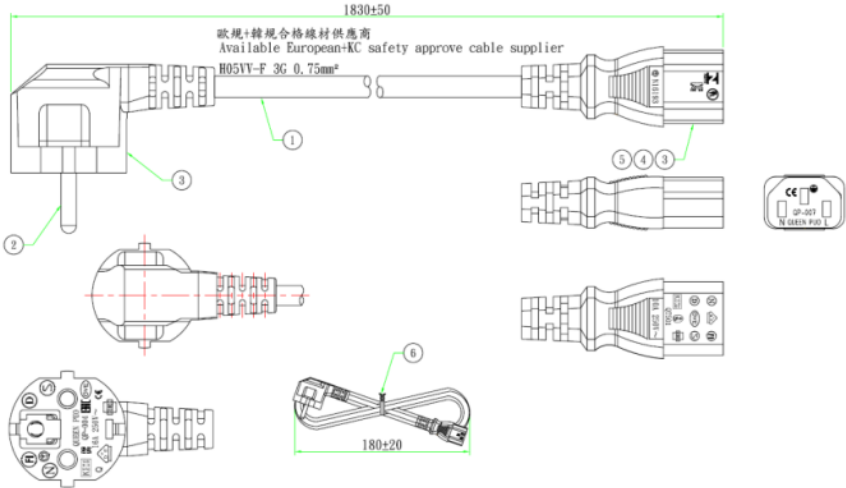

Dd  
064APOWBR4-IPD (CN version)

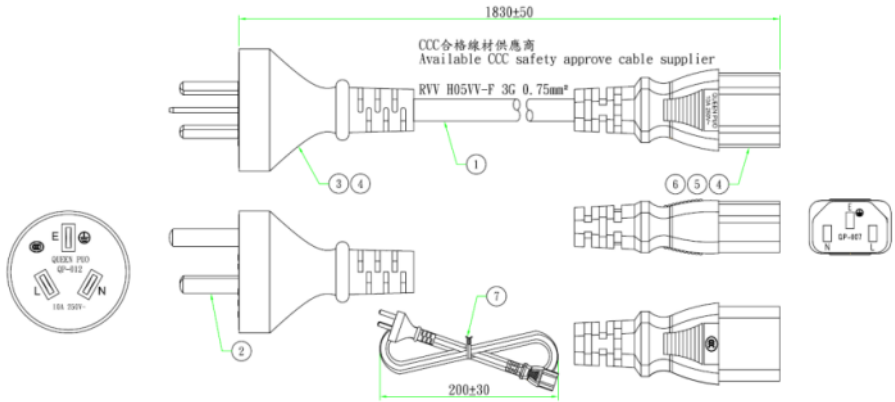

## 7.0 Daughter board introduction

### 7.1 D331 + ERMi Module

Please refer to [ERMi Module | Out-of-Band Management | AVerMedia](#)

OOB demo connection

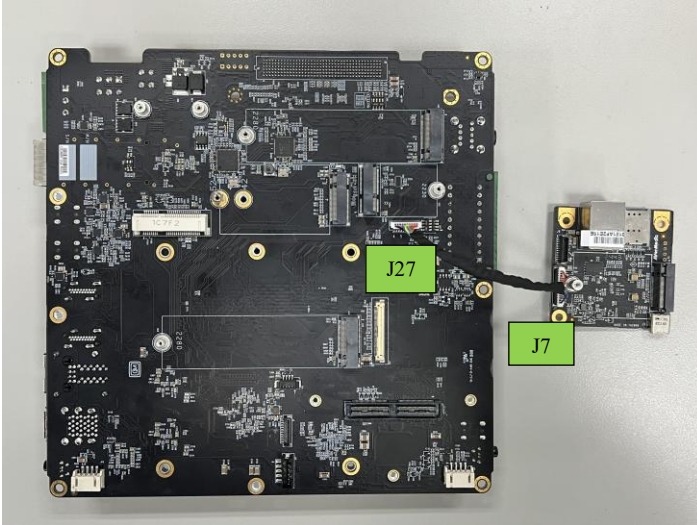

NCSI OOB demo connection

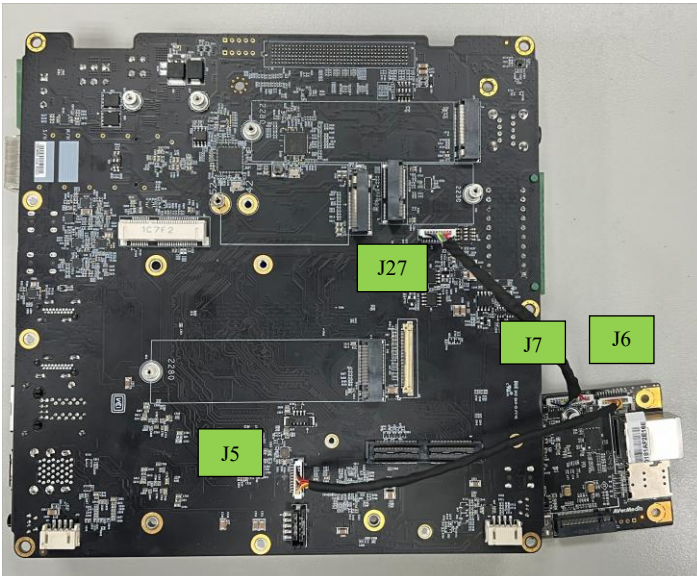

## 7.2 D331 + USB Daughter Board

Please refer to [USB-board | AVerMedia](#)

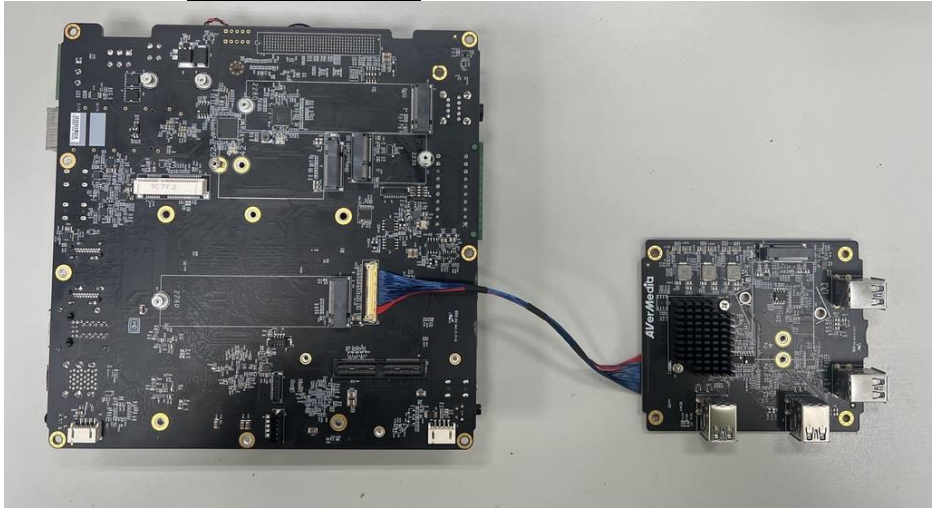

On D331, The red end of the cable must be aligned with the resistor indicated by the yellow arrow and properly connected.

On USB Daughter Board, The red end of the cable must be aligned with the resistor indicated by the yellow arrow and properly connected.

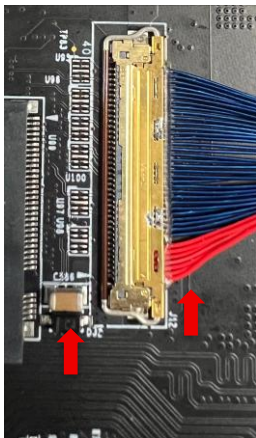

(On D331)

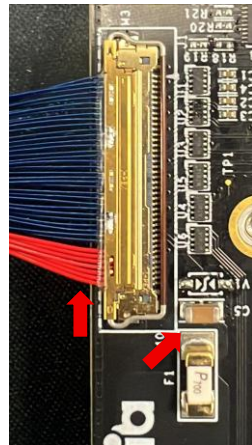

(On USB Daughter Board)

### 7.3 D331 + GMSL Daughter Board

Please refer to [GMSL Board | AVerMedia](#)  
Connect GMSL Daughter Board with J20

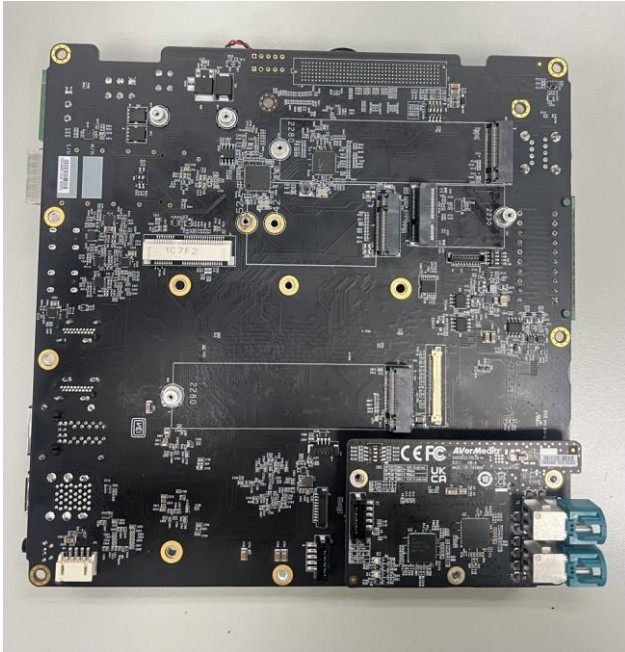

### 7.4 D331 + POE Daughter Board (TBD)

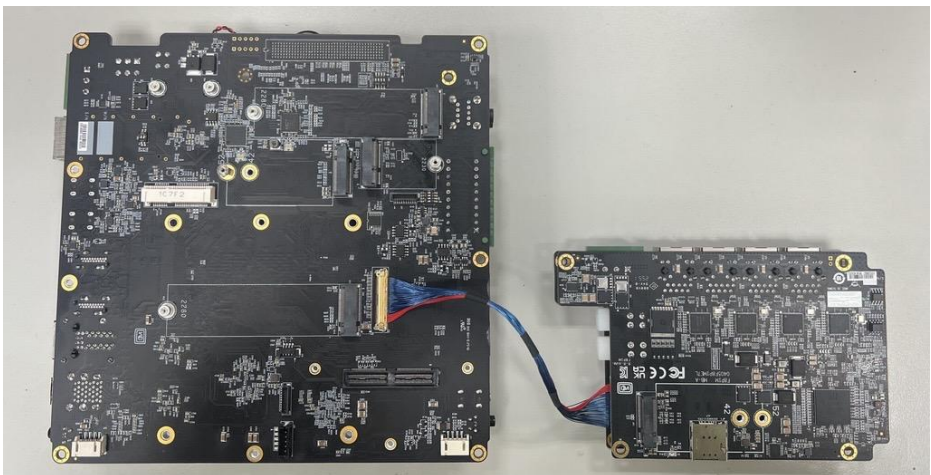

On D331, The red end of the cable must be aligned with the resistor indicated by the yellow arrow and properly connected.

On POE Daughter Board, The red end of the cable must be aligned with the resistor indicated by the yellow arrow and properly connected.

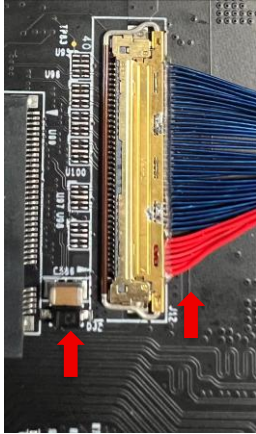

(On D331)

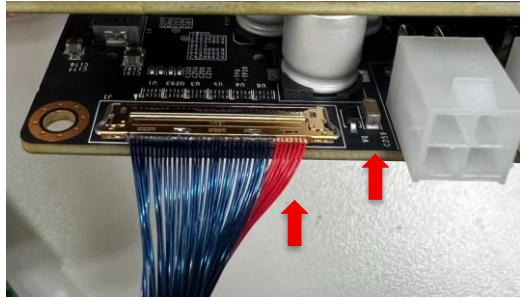

(On POE Daughter Board)